

Article number: 057153301302

Description: HEPCO GV3 bearing BHJ 13 E
Standard for Blind hole Fixing

Measures

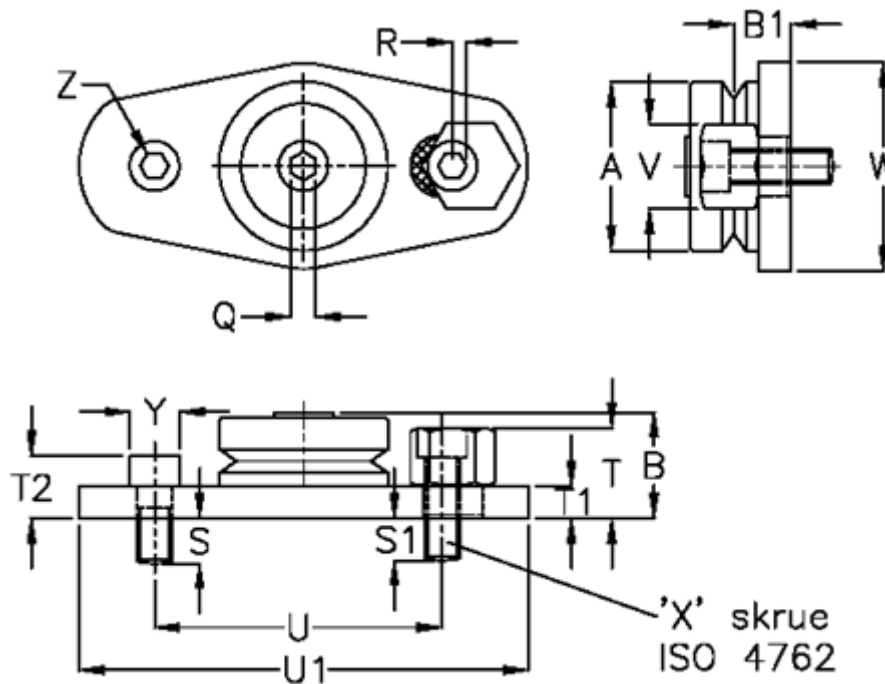

a = 12.7	T1 = 3.75	Y = 5.5
B = 10.1	T2 = 6.75	Z = 8
B1 = 5.47	U = 30.0	
Q = 1.5	U1 = 47.5	
R = 1.0	V = 8	
S = 6.25	W = 20.0	
S1 = 6.6	Weight kg/1000 = 0	
T = 8.5	X = M3	